

SLA5800 Series

Elastomer Sealed, Digital,
General Purpose Thermal Mass Flow
Meters & Controllers for Gases



Model SLA5850
with EtherNet/IP™

The SLA5800 Series thermal mass flow meters and mass flow controllers have gained broad acceptance as the standard for accuracy, stability and reliability. These products have a wide flow measurement range and are suitable for a broad range of temperature and pressure conditions making them well suited for chemical and petrochemical research, laboratory, analytical, fuel cell and life science applications, among others.

Highlights of the SLA5800 Series include: industry leading long-term stability, accuracy backed by superior 17025 metrology systems and methods using calibration systems directly traceable to international standards, and a broad range of analog and digital I/O options to suit virtually any application. An independent diagnostic/service port permits users to set alarms and diagnostics, tune, troubleshoot or change flow conditions without removing the mass flow controller from service.

The SLA5800 Series provides a highly configurable platform based on a simple modular architecture. The feature set was carefully selected to enable drop-in replacement and upgrade of many brands of mass flow controllers. With the wide range of features and options available, the SLA5800 Series provides users with a single platform to support a broad range of applications.

Features	Benefits
Industry leading long-term sensor stability	Increased system uptime and reduced cost of ownership by reducing maintenance and eliminating periodic recipe adjustments and/or recalibrations
User accessible service port	Simplified installation, start-up, troubleshooting and access to diagnostics provides maximum uptime
Alarms and diagnostics	Ensures device is operating within user specified limits for high process yield and uptime
Superior valve technology	Minimum leak-by, wide turndown, fast response and superior corrosion resistant materials reduces overall gas panel cost and increases throughput
High accuracy traceable to international standards	Calibration by verified metrology systems ensures precise process gas flow control
Simple modular design	Easy-to-service elastomer sealed design provides for factory or field service maximizing uptime and reducing total cost of ownership
Adaptable mechanical configurations	Easily retrofit to existing systems

[View SLA5800 Product Page](#)



Superior Thermal Flow Measurement Sensor

Brooks' sensor technology combines:

- Excellent signal to noise performance for good accuracy at low setpoints
- Superior long-term stability through enhanced sensor design manufacturing and extensive burn-in process
- Isothermal packaging to reduce sensitivity to external temperature changes

Advanced Diagnostics

The mass flow controller remains the most complex and critical component in gas delivery systems. When dealing with highly toxic or corrosive gases, removing the mass flow controller to determine if it is faulty should be the last resort. In response to this, Brooks pioneered smarter mass flow controllers with embedded self-test routines and introduced an independent diagnostic/service port to provide the user with a simple interface, for troubleshooting without disturbing flow controller operation.

Wide Flow Range

The SLA5800 Series covers an extremely broad range of flow rates. Model SLA5850 can have a full scale flow as low as 3 ccm. With a high turndown ratio of 100:1 for any full scale range from 1-50 lpm N2 equivalent and 50:1 (250:1 turndown for *Biotech* Options Packages up to 150 LPM) turndown for all other flow rates, accurate gas flow can be measured or controlled down to 0.06 ccm! Model SLA5853 can monitor or control gas flows up to 2500 lpm.

Fast Response Performance

The all-digital electronics and superior mechanical configuration in the SLA5800 Series provide for ultra-fast response characteristics.

Broad Array of Communication Options

Traditional 0-5 Vdc and 4-20mA analog options as well as RS485 digital communications are available ("S-protocol", based on HART). Control interfaces via digital network protocols including EtherNet/IP™, PROFINET, DeviceNet®, and Profibus® are also available. EtherNet/IP™ and PROFINET are a modern, high-speed digital protocol that permits multiple, additional diagnostics to provide MFC users with rich, real-time system information. DeviceNet® has been certified by the ODVA (Open DeviceNet Vendor's Association). EtherNET/IP™ and PROFINET are pending industry conformance certification.

Multi-gas/Multi-range Capabilities

The SLA5800 Series multi-gas and multi-range capabilities reduce inventory. Storage and pre-programming of up to 6 gas calibrations easily permits users to switch between different gasses and ranges on a single device.

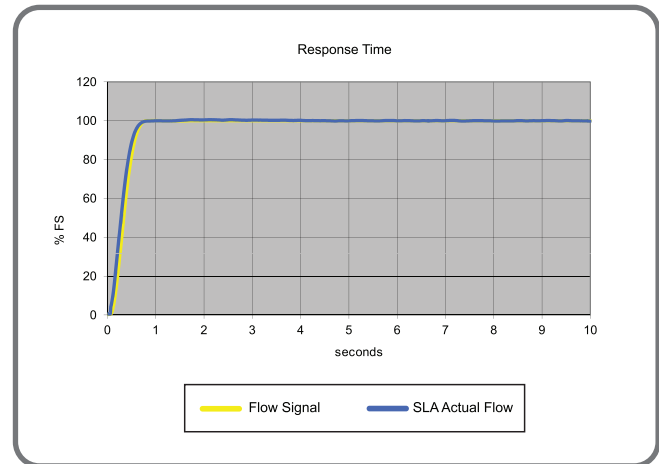
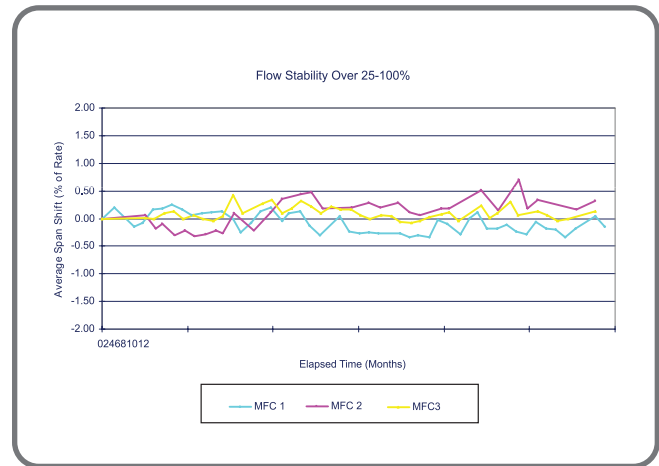

SLA5800 Series MFC

3.6L He 3.6L Ar 2.6L H2
 2.6L CO 2.0L NH3 2.6L N2

Multi-gas/Multi-range capability allows your SLA5800 Series to be programmed for a variety of different gases and flow ranges

SLA5800 Series Standard

Flow Ranges and Pressure Ratings:

Mass Flow Controller Model	Mass Flow Meter Model	Flow Ranges N2 Eq. Ratings		Maximum Operating Pressure		PED Module H Category
		Min. F.S.	Max. F.S.	Standard ¹	Optional ¹	
SLA5850	SLA5860	0.003	50 slpm	1500 psi/103 bar	4500 psi/310 bar @ Maximum Flow of 10 lpm N ₂	SEP
SLA5851	SLA5861	15	150 slpm ²	1500 psi/103 bar	NA ³	SEP
SLA5853	SLA5863	100	2500 slpm	1000 psi/70 bar	NA	Category 1 for all 150 lb flanges

¹ Sanitary fittings - Model code 5A, 5B, 5C, 5D & 5E rated to 500 psi Maximum Pressure

² 600 lpm of H₂ possible with decreased accuracy; > 40 psig inlet required for flows greater than 100 lpm N₂ equivalent.

³ 4500 psi/310 bar available as a special on SLA5861 only

	SLA5850/60	SLA5851/61	SLA5853/63
PERFORMANCE			
Full Scale Flow Range (N₂, Eq.)	0.003 - 50 slpm	15 - 150 slpm	100 - 1100 slpm
Flow Accuracy – 17025 Certified Devices (includes linearity, excludes calibration system measurement uncertainty per SEMI E69) ⁴	±0.6% of S.P. (20-100% FS), ±0.12% FS (<20% FS)		±0.6% of FS
Flow Accuracy (includes linearity and calibration system measurement uncertainty per SEMI E69) ⁴	±0.9% of S.P. (20-100% FS), ±0.18% of FS (<20% FS)		±1.0% of FS
Control Range	100:1 for F.S. from 1-50 slpm (50:1 for all other F.S. flows)		
Repeatability & Reproducibility	0.20% S.P.		
Linearity	Included in accuracy		
Response Time (Settling Time within ±2% F.S. for 0-100% command step)	< 1 second		< 3 seconds
Zero Stability	< ± 0.2% F.S. per year		
Temperature Coefficient	Zero: <0.05% of F.S. per °C. Span: <0.1% of S.P. per °C		
Pressure Coefficient	±0.03% per psi (0-200 psi N ₂)		
Attitude Sensitivity	<0.2% F.S. maximum deviation from specified accuracy after re-zeroing		

⁴ Accuracy at calibration conditions ; accuracy spec valid across the full control range.

RATINGS			
Operating Temperature Range	-14 to 65°C (7 to 149°F) ⁵		
Minimum Pressure Differential (Controllers)	5 psi/0.35 bar	10 psi/0.69 bar	Min.: 7.5 psi/0.52 bar at 500 lpm Min.: 14.5 psi/1.00 bar at 1000 lpm Min.: 35.0 psi/2.41 bar at 2500 lpm
Maximum Pressure Differential (Controllers)	Application specific up to 4500 psi/300 bar (limited conditions) ⁶	50 psi/3.45 bar	300 psi/20.0 bar
Leak Integrity (external)	1x10 ⁻⁹ atm. cc/sec He		
Valve Shut Down (leak by)⁷	<1% of FS		

MECHANICAL	
Valve Type	Normally Closed, Normally Open, Meter
Primary Wetted Materials	316, 316/316L Stainless Steel, High Alloy-Stainless Steel, Viton® fluoroelastomers (optional Buna-N, Kalrez®, Teflon®/Kalrez®, and EPDM)

DIAGNOSTICS	
Status Lights	MFC Health, Network Status
Alarms⁸	Control Valve Output, Flow Totalizer, Network Interruption, Over Temperature, Power Surge/Sag, Service Required
Diagnostic/Service Port	RS485 via 2.5mm jack

⁵ Hazardous area certifications have a temperature range limitation of 0-65°C.

⁶ >1500 psi DP as a Special Order

⁷ Metal and Teflon Seats <5% of Full Scale

⁸ Alarm modes are dependent on the communications interface. These are described in the corresponding digital communication interface manual.

Electrical Specifications

Communication Protocol	RS485/Analog	Profibus [®]	DeviceNet™	EtherCAT™	EtherNet/IP™ & PROFINET
Electrical Connection	1 x 15-pin Male Sub-D, (A)	1 x 15-pin Male Sub-D/ 1 x 9-pin Female Sub-D	1 x M12 with threaded coupling nut (B)	1 x 5-pin M8 with threaded coupling nut 2 x RJ45	1 x 5-pin M8 with threaded coupling nut / 2 x RJ45
Analog I/O	0-5 V, 1-5 V, 0-10 V, 0-20 mA, 4-20 mA		N/A	0-5V	N/A
Power Max./Purge	From +13.5 Vdc to +27 Vdc		From +11 Vdc to +25 Vdc	From +13.5 Vdc to +27 Vdc	From +13.5 Vdc to +27 Vdc
Power Requirements Watts, Max.	Valve Orifice > 0.032": 8W Valve Orifice ≤ 0.032": 5W Without Valve: 2W		Valve Orifice > 0.032": 10W Valve Orifice ≤ 0.032": 7W Without Valve: 4W	Valve Orifice > 0.032": 8.5W Valve Orifice ≤ 0.032": 5.5W Without Valve: 2.5W	Valve Orifice > 0.032": 10W Valve Orifice ≤ 0.032": 7W Without Valve: 3W
Web-based Network Settings Interface	N/A		N/A	N/A	The Default Network Address is 192.168.100.1 EtherNet/IP: Default Network Configuration is DHCP PROFINET: The Default Name is "sla-mfc"

RS485/Analog

Profibus[®]

FLOW INPUT (VOLTAGE) SPECIFICATIONS

Nominal Range	0-5 Vdc, 1-5 Vdc or 0-10 Vdc
Full Range	(-0.5) -11 Vdc
Absolute Max.	18 V (without damage)
Input Impedence	>990 kOhms
Required Max. Sink Current	0.002 mA

FLOW INPUT (CURRENT) SPECIFICATIONS

Nominal Range	4-20 mA or 0-20 mA
Full Range	0-22 mA
Absolute Max.	24 mA (without damage)
Input Impedence	100 Ohms

FLOW OUTPUT (VOLTAGE) SPECIFICATIONS

Nominal Range	0-5 Vdc, 1-5 Vdc or 0-10 Vdc
Full Range	(-1)-11 Vdc
Min Load Resistance	2 kOhms

FLOW OUTPUT (CURRENT) SPECIFICATIONS

Nominal Range	0-20 mA or 4-20 mA
Full Range	0-24.6 mA (@ 0-20 mA); 3.8-24.6 mA (@ 4-20 mA)
Max. Load	380 Ohms (for supply voltage: < 16 Vdc)

ANALOG I/O ALARM OUTPUT*

Type	Open Collector
Max. Closed (On) Current	25 mA
Max. Open (Off) Leakage	1 μA
Max. Open (Off) Voltage	30 Vdc

ANALOG I/O VALVE OVERRIDE SIGNAL SPECIFICATIONS**

Floating/Unconnected	Instrument controls valve to command set point
VOR < 0.3 Vdc	Valve Closed
1 Vdc < VOR < 4 Vdc	Valve Normal
VOR > 4.8 Vdc	Valve Open
Input Impedence	800 kOhms
Absolute Max. Input	(-25 Vdc) < VOR < 25 Vdc (without damage)

*The Alarm Output is an open collector or "contact type" that is CLOSED (on) whenever an alarm is active. The Alarm Output may be set to indicate any one of various alarm conditions.

**The Valve Override Signal (VOR) is implemented as an analog input which measures the voltage at the input and controls the valve based upon the measured reading as shown in this section.

SLA5800 Series *Biotech*

Efficiency and simplicity combine to improve bioprocessing performance with the new SLA5800 Series *Biotech* MFC. It incorporates several features created specifically to help streamline MFC purchasing, improve process gas control, enhance flexibility and satisfy regulatory requirements.

To serve the unique requirements of your bioprocesses, Brooks Instrument has created two SLA5800 Series *Biotech* options packages, built on the proven performance of the bioprocess-leading SLA5800 Series MFC .

As noted in the ordering instructions, all options are combined into packages with convenient ordering codes, eliminating the need to order options individually.

SLA5800 Series *Biotech* Options Packages

Performance Package - Model Code S

Includes multiple performance enhancements reducing cost of operation

High Turndown Ratio

Reduces number of MFCs needed to control wide flow ranges

Enhanced Control Valve

Extremely low leak rate can eliminate need for redundant valves

Enhanced Sensor Design

Clean welded construction meets industry standards for cleanliness

Pre-calibrated Multi-Gas Pages¹

Air, CO₂, N₂ & O₂ : gas pages can be changed in situ to reduce the variety of spare instruments kept in stock

Premium Package - Model Code T

Performance Package Features plus:

Includes premium materials and associated certificates tailored to industry requirements

Class VI Elastomers

USP Class VI and ADI Free O-Rings and Valve Seats²
(Certificate Included)

Certifications

Materials of Construction (wetted path)
2.2 Material Cert³
ICC Calibration Traceability

¹ CO₂ Actual Gas Calibration available for SLA5850/60 & SLA5851/61. Use Model Code U for Performance Package, and Model Code V for Premium package.

² All Class VI Viton elastomers are also compliant to 21CFR177.2600 (Title 21 – Food & Drugs, Chapter I - FDA)

³ 3.1 Material Certs for pressure boundary components available as an option on Premium Package.

Note: All Communications protocols listed in the Electrical Specification Table, above, are available with any Biotech Option

Learn More About
the SLA5800 Series *Biotech*

SLA5800 Series *Biotech*

Performance	SLA5850/60	SLA5851/61	SLA5853/63	
Full Scale Flow Range ²	5 sccm -50 slpm	15 -150 ¹ slpm	100 - 1100 slpm	1100 - 2500 slpm
Gasses Supported ²	Air, CO ₂ , Nitrogen & Oxygen			
Flow Accuracy (includes linearity and calibration system measurement uncertainty per SEMI E69) ³	±0.9% of S.P. (20-100% FS), ±0.18% of F.S. (< 20% FS)			±1.0% of FS
Repeatability & Reproducibility	0.20% S.P.			
Turndown (control range)	250:1	250:1	150:1	
Response Time	< 1 Second	< 1 Second	< 3 Seconds	
Zero Stability	< ± 0.2% F.S. per year			
Temperature Coefficient	<0.05% F.S. per °C			
Valve Shut Down (leak-by)	0.005 sccm		15.6 sccm	

1 Maximum flow depends on pressure conditions; consult Applications Engineering for details

2 Calibration on CO₂ available as an option on SLA5850/60 & SLA5851/61

3 Accuracy at Calibration Conditions ; Accuracy spec valid across the full control range

Ratings	SLA5850/60	SLA5851/61	SLA5853/63
Inlet Pressure Range ⁴	5 psig to 60 psig	10 psig to 60 psig	8 psig to 60 psig
Outlet Pressure Range	Atmospheric	Atmospheric	Atmospheric
Maximum Pressure	Same as standard		
Differential Pressure (controller only)	60 psig ⁵		
Valve Configuration	Standard SLA with Special Factory Tuning/Normally Closed		
Ambient Temperature Range	-14°C - 50°C		
Sensor Design	Enhanced construction to meet industry standards for cleanliness		

4 Performance at minimum inlet pressure will be gas and flow range dependent. Consult Applications Engineering for details.

5 Maximum pressure drop. Actual pressure drop will be gas and flow dependent. Consult Applications Engineering for details.

Code Description	Code Option	Option Description
Biotech Options Packages	S	Performance Package ⁶
	T	Premium Package ⁷
	U	Performance Package with CO ₂ Calibration ⁸
	V	Premium Package with CO ₂ Calibration ⁸

6 Performance Package must be ordered for basic *Biotech* model features;

7 Premium Package includes Performance Package features.

8 Not available on SLA5853 or SLA5863

Learn More About
the SLA5800 Series *Biotech*

SLA5850/SLA5851/SLA5860/SLA5861

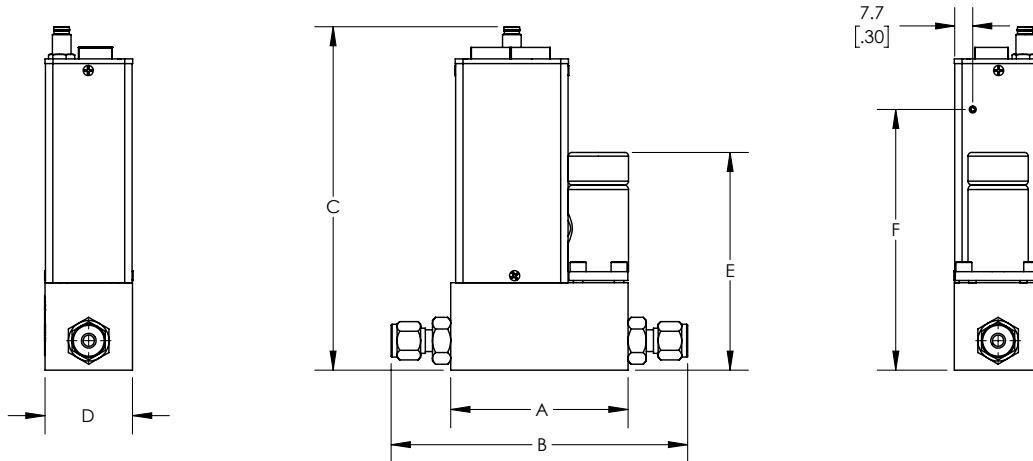

FITTINGS - DIMENSION "B"

FITTING	50	51**	60	61**
	mm / inch	mm / inch	mm / inch	mm / inch
9/16"-18 UNF	N/A	93.5 / 3.68	N/A	80.0 / 3.15
1/8" Tube COMP.	123.1 / 4.85	N/A	105.3 / 4.15	N/A
1/4" TUBE COMP.*	127.7 / 5.03	144.8 / 5.7	109.9 / 4.33	131.3 / 5.17
3/8" TUBE COMP.*	130.7 / 5.15	147.9 / 5.82	112.9 / 4.45	134.4 / 5.29
1/2" TUBE COMP.*	N/A	N/A	117 / 4.61	138.4 / 5.45
1/4" VCO	116 / 4.56	141.3 / 5.56	98.2 / 3.87	119.6 / 4.71
3/8"-1/2" VCO	127.2 / 5.01	144.3 / 5.68	N/A	N/A
1/4" NPT-F	118.5 / 4.67	133.2 / 5.24	98.8 / 3.89	122.2 / 4.81
3mm TUBE COMP.*	122.2 / 4.81	135.7 / 5.34	104.4 / 4.11	N/A
6mm TUBE COMP.*	127.8 / 5.03	144.9 / 5.71	110 / 4.33	131.3 / 5.17
10mm TUBE COMP.*	131.1 / 5.16	148.3 / 5.84	113.5 / 4.47	134.9 / 5.31
1/4" VCR	124.1 / 4.89	152.5 / 5.98	106.3 / 4.19	127.8 / 5.03
3/8"-1/2" VCR	131.7 / 5.19	148.9 / 5.86	113.9 / 4.48	N/A
1/4" RC (BSP)	116.6 / 4.59	133.7 / 5.27	98.8 / 3.89	120.2 / 4.73
1/2" SANITARY	140.5 / 5.53	157.5 / 6.2	122.7 / 4.83	144.0 / 5.67
3/4" SANITARY	140.5 / 5.53	157.5 / 6.2	122.7 / 4.83	144.0 / 5.67

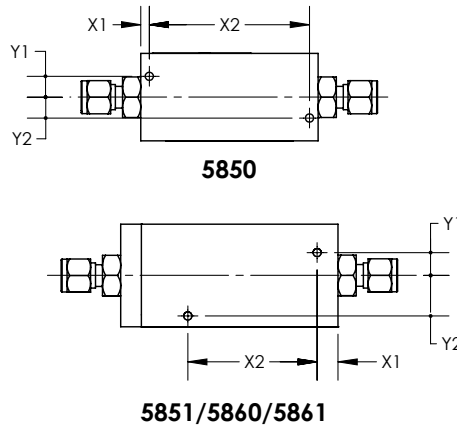

MOUNTING HOLES

Model	X1	X2	Y1	Y2
	mm / inch	mm / inch	mm / inch	mm / inch
5850	3.7 / .14	69.0 / 2.72	9.0 / .35	9.0 / .35
5851	9.0 / .35	55.7 / 2.19	9.9 / .39	17.4 / .68
5860	9.1 / .36	40.4 / 1.59	10.2 / .40	10.2 / .40
5861	11.7 / .46	39.4 / 1.55	17.3 / .68	17.3 / .68

*OVERALL LENGTH FINGER TIGHT

**DEVICES WITH 5848 INLET FILTER WILL BE 2" OR 1.42" LONGER

ELECTRO/MECHANICAL DIMENSIONS

Model	A	C						D	E			F
		Analog RS485	Profibus	DeviceNet	EtherCat	ProfiNet/EtherNet	Foundation Fieldbus		N.C	N.O.	NO VALVE	
		mm / inch	mm / inch	mm / inch	mm / inch	mm / inch	mm / inch		mm / inch	mm / inch	mm / inch	
5850	76.4/3.01	137.4/5.41	137.4/5.41	134.1/5.28	148.0/5.83	148.0/5.83	148.0/5.83	37.7/1.48	93.2/3.67	100.3/3.95	45.7/1.80	112.3/4.42
5851	93.5/3.68	143.9/5.66	143.9/5.66	140.5/5.53	154.4/6.08	154.4/6.08	154.4/6.08	44.2/1.74	100.3/3.95	107.8/4.24	52.1/2.05	118.8/4.68
5860	58.6/2.31	137.4/5.41	137.4/5.41	134.1/5.28	148.0/5.83	148.0/5.83	148.0/5.83	37.7/1.48	N/A	N/A	N/A	112.3/4.42
5861	80.0/3.15	143.9/5.66	143.9/5.66	140.5/5.53	154.4/6.08	154.4/6.08	154.4/6.08	44.2/1.74	N/A	N/A	N/A	118.8/4.68

SLA5853/SLA5863

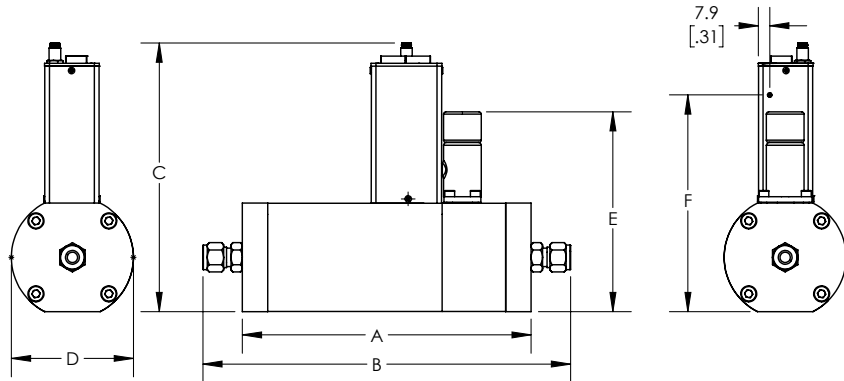

FITTING CONFIGURATIONS

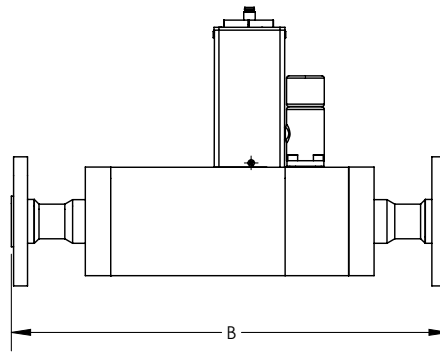
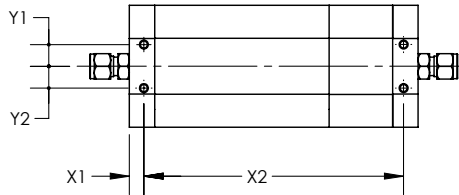

FLANGE CONFIGURATIONS

"B" Dimension		
FITTING	53	63
	mm / inch	mm / inch
9/16"-18 UNF	199/7.8	155/6.1
1-1/16" - 12 UN	199/7.8	155/6.1
1-5/16" - 12UN	199/7.8	155/6.1
3/8" TUBE COMP.*	253/10	209/8.2
1/2" TUBE COMP.*	267/10.5	223/8.8
3/4" TUBE COMP.*	267/10.5	223/8.8
1" TUBE COMP.*	274/10.8	232/9.1
3/8"-1/2" VCO	249/9.8	206/8.1
3/4" VCO	257/10.1	213/8.4
1" VCO	259/10.2	216/8.5
1/2" NPT	199/7.8	155/6.1
1" NPT	199/7.8	155/6.1
1-1/2" NPT	199/7.8	155/6.1
12mm TUBE COMP.*	N/A	219/8.62
3/8"-1/2" VCR	257/10.1	213/8.4
3/4" VCR	279/11	236/9.3
1/2" RC (BSP)	199/7.8	155/6.1
1" RC (BSP)	199/7.8	155/6.1
1/2" SANITARY	262.6/10.34	220/8.64
3/4" SANITARY	262.6/10.34	220/8.64
1" SANITARY	262.6/10.34	220/8.64
ANSI 1/2" 150#	299/11.8	256/10.1
ANSI 1/2" 300#	299/11.8	256/10.1
ANSI 1" 150#	299/11.8	256/10.1
ANSI 1" 300#	299/11.8	256/10.1
ANSI 1.5" 150#	299/11.8	256/10.1
ANSI 1.5" 300#	299/11.8	256/10.1
ANSI 2" 150#	299/11.8	256/10.1
ANSI 2" 300#	299/11.8	256/10.1
DIN DN15 PN40	299/11.8	256/10.1
DIN DN25 PN40	299/11.8	256/10.1
DIN DN40 PN40	299/11.8	256/10.1

MOUNTING HOLES				
Model	X1	X2	Y1	Y2
	mm / inch	mm / inch	mm / inch	mm / inch
5853	10.0/.39	178.8/7.04	15.0/.59	15.0/.59
5863	10.0/.39	135.0/5.32	15.0/.59	15.0/.59

*OVERALL LENGTH FINGER TIGHT

ELECTRO/MECHANICAL DIMENSIONS										
Model	A	C						D	E	F
		Analog RS485	Profibus	DeviceNet	EtherCat	ProfiNet/EtherNet	Foundation Fieldbus			
	mm / inch	mm / inch	mm / inch	mm / inch	mm / inch	mm / inch	mm / inch	mm / inch	mm / inch	
5853	199.0/7.8	174.3/6.86	174.3/6.86	171.0/6.73	184.9/7.28	184.9/7.28	184.9/7.28	84.0/3.31	137.0/5.4	149.2/5.87
5863	155.0/6.1	174.3/6.86	174.3/6.86	171.0/6.73	184.9/7.28	184.9/7.28	184.9/7.28	84.0/3.31	N/A	149.2/5.87

Access our library of CAD Drawings

Code Description	Code Option	Option Description
I. Base Model Numbers	SLA	
II. Package / Finish Specifications	58	Standard Elastomer Series
III. Function	5	Mass Flow Controller
	6	Mass Flow Meter
IV. Gas or Range	0	3 ccm - 50 lpm
	1	20 - 100 lpm
	3	100 - 2500 lpm
V. Digital I/O Communication	A	None (select applicable analog I/O)
	D	DeviceNet I/O (with 5-pin micro connector)
	E	EtherCAT I/O (with 5-pin Nano-change connector)
	P	Profibus (2x sub-D)
	S	RS485 (select applicable analog I/O)
	7	EtherNET/IP™ I/O (with 5 Pin Nano-change M8 Connector)
	8	PROFINET (with 5 Pin Nano-change M8 Connector)
VI. Mechanical Connection (Body size 0 & 1 only)	1A	Without adapters, 9/16" - 18 UNF
	1B	1/4" tube compression
	1C	1/8" tube compression
	1D	3/8" tube compression
	1E	1/4" VCR
	1F	1/4" VCO
	1G	1/4" NPT
	1H	6mm tube compression
	1J	10mm tube compression
	1L	3/8"-1/2" VCR
	1M	3/8"-1/2" VCO
	1P	1/2" tube compression
	1S	Elastomer downport
	1T	1/4" RC (BSP)
	1Y	3mm tube compression
	B1	1/4" tube compression w/Filter
	C1	1/8" tube compression w/Filter
	D1	3/8" tube compression w/Filter
	E1	1/4" VCR w/Filter
	F1	1/4" VCO w/Filter
	G1	1/4" NPT w/Filter
	H1	6mm tube compression w/Filter
	J1	10mm tube compression w/Filter
	L1	3/8"-1/2" VCR w/Filter
	M1	3/8"-1/2" VCO w/Filter
	P1	1/2" tube compression w/Filter
	T1	1/4" RC (BSP) w/Filter
	Y1	3mm tube compression w/Filter
	5A ¹	9/16-18 X 1/2" Sanitary
	5B ¹	9/16 -48 X 3/4" Sanitary
	VI. Mechanical Connection (Body size 3 only)	2A
2B		1-1/16"-12 SAE/MS
2C		3/8" tube compression
2D		1/2" tube compression
2E		3/4" tube compression
2F		1" tube compression
2G		1/2" NPT (F)
2H		1" NPT (F)
2J		1-1/2" NPT (F)
2K		1/2" VCO
2L		3/4" VCO
2M		1/2" VCR
2N		1/2" RC (BSP)
2P		1" RC (BSP)
2R		1-5/16"-12 SAE/MS
2S		1" VCO
2T		3/4" VCR
2U		1" VCR
3A		DIN DN15 PN40 Flange
3B		DIN DN25 PN40 Flange
3C		DIN DN40 PN40 Flange
3D		DIN DN50 PN40 Flange
5C ¹		1 1/16-12 X 1/2" Sanitary
5D ¹		1 1/16-12 X 3/4" Sanitary
5E ¹		1 1/16-12 X 1" Sanitary

Code Description	Code Option	Option Description
VI. Mechanical Connection (Body size 3 only)	3E	ANSI 1/2" 150# RF Flange
	3F	ANSI 1/2" 300# RF Flange
	3G	ANSI 1" 150# RF Flange
	3H	ANSI 1" 300# RF Flange
	3J	ANSI 1-1/2" 150# RF Flange
	3K	ANSI 1-1/2" 300# RF Flange
VII. O-ring Material	A	Viton
	B	Buna
	C	PTFE
	D	Kalrez
	E	EPDM
	J	USP Class VI and ADI Free requirements - Viton/FKM ²
L	USP Class VI - EPDM	
VIII. Valve Seat	A	None (Sensor only)
	B	Viton (for body size 3, diaphragm material = PTFE)
	C	Buna (for body size 3, diaphragm material = PTFE)
	D	Kalrez (for body size 3, diaphragm material = PTFE)
	E	EPDM (for body size 3, diaphragm material = PTFE)
	F	PTFE
	G	Metal (for body size 3, diaphragm material = PTFE)
IX. Valve Type	0	None (Sensor only)
	1	Normally closed
	2	Normally closed (Pressure diff. >30 psig (2 bar))
	3	Normally closed (Pressure diff. <30 psig (2 bar))
	4	Normally closed - high pressure
	5	Normally open
X. Analog I/O Communications	A	None - Digital Communications only
	B	0-5 Volt 0-5 Volt 15-pin D-conn
	C	4-20 mA 4-20 mA 15-pin D-conn
	L	1-5 Volt 1-5 Volt 15-pin D-conn
	M	0-20 mA 0-20 mA 15-pin D-conn
	0	0-10 Volt 0-10 Volt 15-pin D-conn
	1	0-5 Volt 4-20 mA 15-pin D-conn
	2	0-5 Volt 0-20 mA 15-pin D-conn
	3	4-20 mA 0-5 Volt 15-pin D-conn
	4	0-20 mA 0-5 Volt 15-pin D-conn
9	0-10 Volt 0-5 Volt 15-pin D-conn	
XI. Power Supply Inputs	1	+15 Vdc
	2	24 Vdc
XII. Output Enhancements	A	Standard response
	S	Biotech Performance Package
	T	Biotech Premium Package
	U	Performance Package with CO2 Calibration ³
	V	Premium Package with CO2 Calibration ³
XIII. Certification	1	Safe Area
	2	For Zone 2 ATEX/IECEX
	4	Div. 2/Zone 2 UL Recognized

Sample Standard Model Code

I	II	III	IV	V	VI	VII	VIII	IX	X	XI	XII	XIII
SLA	58	5	0	A	1A	A	B	1	B	1	A	1





1 Sanitary Fittings Model Code 5A, 5B, 5C, 5D and 5E are limited to 500 PSI Maximum Pressure

2 O-ring material is compliant to 21CFR177.2600 (Title 21 – Food & Drugs, Chapter I - FDA)

3 CO2 Actual Gas Calibration available for SLA5850/60 & SLA5851/61

Request a Quote

Certifications

Mark	Agency	Certification	Applicable Standard	Details
	UL (Recognized)	Class I, Div 2, Group A, B, C, D Class I, Zone 2, IIC T4 Class II, Zone 22 Enclosure: Type 1/IP40	UL & CSA Standards	E73889 Vol 3, Sec 4
	ATEX	II 3 G Ex nA IIC T4 Gc	EN60079-0:2012 EN 60079-15:2010	KEMA 04ATEX 1118X
	IECEX	II 3 G Ex nA IIC T4 Gc	IEC 60079-0:2011 IEC 60079-15:2010	IECEX DEK 14.0072X
	KOSHA	Ex nA IIC T4		15-AV4BO-0641 15-AV4BO-0640
	CE	EMC Directive 2014/30/EU Directive 2011/65/EU	EN:61326-1:2013	EMC RoHS

ATEX/IECEX Special Conditions: please see Certification section of the SLA5800 Installation & Operations Manual

Service and Support

Brooks is committed to assuring all of our customers receive the ideal flow solution for their application, along with outstanding service and support to back it up. We operate first class repair facilities located around the world to provide rapid response and support. Each location utilizes primary standard calibration equipment to ensure accuracy and reliability for repairs and recalibration and is certified by our local Weights and Measures Authorities and traceable to the relevant International Standards.

Visit www.BrooksInstrument.com to locate the service location nearest to you.

START-UP SERVICE AND IN-SITU CALIBRATION

Brooks Instrument can provide start-up service prior to operation when required. For some process applications, where ISO-9001 Quality Certification is important, it is mandatory to verify and/or (re)calibrate the products periodically. In many cases this service can be provided under in-situ conditions, and the results will be traceable to the relevant international quality standards.

CUSTOMER SEMINARS AND TRAINING

Brooks Instrument can provide customer seminars and dedicated training to engineers, end users, and maintenance persons. Please contact your nearest sales representative for more details. Due to Brooks Instrument's commitment to continuous improvement of our products, all specifications are subject to change without notice.

TRADEMARKS

Brooks.....Brooks Instrument, LLC
All other trademarks are the property of their respective owners.



DS-TMF-SLA5800-Series-RevB-MFC-eng/2020-5

Global Headquarters

Brooks Instrument
407 West Vine Street
Hatfield, PA
19440-0903 USA

Toll-Free (USA): 888-554-FLOW
T: 215-362-3500
F: 215-362-3745

BrooksAM@BrooksInstrument.com

A list of all Brooks Instrument locations and contact details can be found at www.BrooksInstrument.com

© Copyright 2020 Brooks Instrument, LLC All rights reserved. Printed in U.S.A.

BROOKS[®]
INSTRUMENT
Beyond Measure